

### Features

- 118 airjets release thousands of heated bubbles that surround and support the body in a warm massage.
- Automatic and manual purge cycles remove residual water from air channels after use.
- Variable-speed blower lets you adjust Heated BubbleMassage™ massage intensity to 18 levels.
- Single-speed whirlpool revitalizes sore muscles.
- 8 fully adjustable whirlpool jets allow users to customize hydromassage flow and direction at each jet.
- Comfort Depth® design offers a convenient 19" step-over height while retaining the same depth as a standard 21" bath.
- Integral lumbar support.
- Slotted overflow allows for deep soaking.
- Integral flange helps prevent water from seeping behind wall and simplifies alcove installation.
- Textured bottom surface.
- Coordinates with other products in the Archer collection.
- Built-in 600W BubbleMassage™ heater warms humidified air before it enters the bath.
- Automatic and manual purge cycles remove residual water from air channels after use.



**ADA**

### Codes/Standards

ASME A112.19.7/CSA B45.10  
 CSA B45.5/IAPMO Z124  
 ASTM E162  
 ASTM E662  
 UL 1795  
 CSA C22.2 No. 218.2  
 ADA  
 ICC/ANSI A117.1

### Material

- Acrylic.

### Hydrotherapy

- Whirlpool.

### Technology

- Auto-shutoff timer on blower allows users to enjoy Heated BubbleMassage™ experience for 60 minutes before turning off.
- User interface: electronic keypad control for Heated BubbleMassage™; air switch actuator for whirlpool.

### Installation

- Left drain.

### Required Products/Accessories

K-7271 Brass Slotted Overflow Bath Drain

or

K-7272 PVC Slotted Overflow Bath Drain

### Recommended Products/Accessories

K-24916 Wireless Music Kit

K-1446 Remote Installation Kit

K-23726 Drain treatment







K-23732 Tub & shower cleaner

### KOHLER® Plastic Baths and Receptors Lifetime Limited Warranty KOHLER® Hydrotherapy Components Five-Year Limited Warranty

See website for detailed warranty information.

### Available Colors/Finishes

*Color tiles intended for reference only.*

| Color   | Code | Description   |
|---|------|---------------|
|  | 0    | White         |
|  | 96   | Biscuit       |
|  | NY   | Dune          |
|  | 95   | Ice™ Grey     |
|  | 58   | Thunder™ Grey |
|  | 7    | Black Black™  |

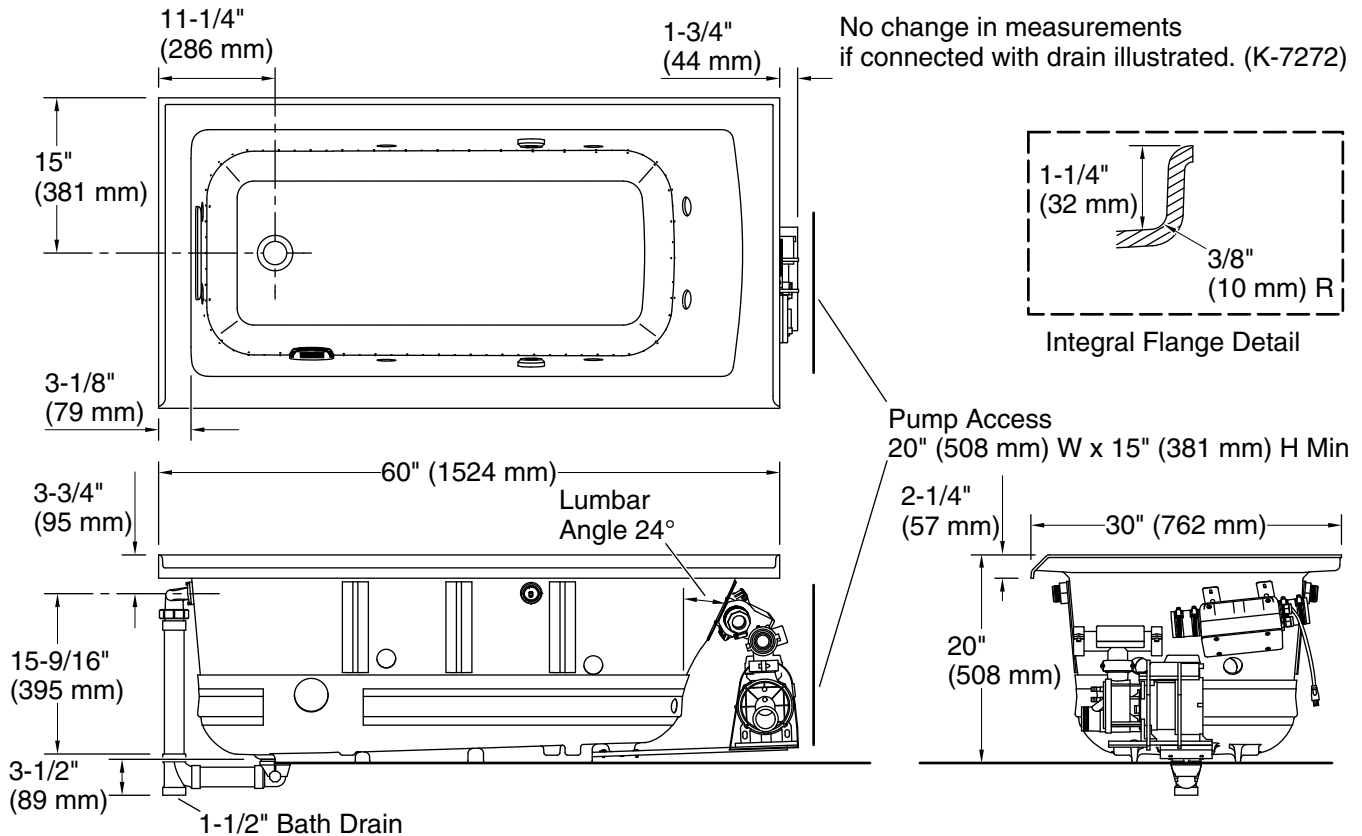

### Required Electrical Service

Three dedicated circuits required, protected with Class A Ground-Fault Circuit-Interrupter (GFCI). Outside North America, this device may be known as a Residual Current Device (RCD).

|               |                    |
|---------------|--------------------|
| Pump, Heater: | 120 V, 15 A, 60 Hz |
| Heater:       | 120 V, 15 A, 60 Hz |
| Blower:       | 120 V, 15 A, 60 Hz |

### Technical Information

All product dimensions are nominal.

|                              |  |
|------------------------------|--|
| Installation:                | Three-wall alcove  |
| Drain location:              | Left   |
| Basin area, bottom:          | 45-1/8" x 19-11/16" (1146 mm x 500 mm)   |
| Basin area, top:             | 52-1/8" x 22-1/16" (1324 mm x 560 mm)  |
| Weight:                      | 138 lbs (62.6 kg)  |
| Minimum floor load:          | 51.3 lbs/ft <sup>2</sup> (250.5 kg/m <sup>2</sup> )  |
| Water depth:                 | 15-1/8" (384 mm)   |
| Water capacity:              | 57 gal (215.8 L)   |
| Electrical component rating: | Pump: 120 V, 7 A, 60 Hz<br>Heater: 120 V, 5 A, 60 Hz<br>Heater: 120 V, 12 A, 60 Hz<br>Blower: 120 V, 10 A, 60 Hz |

### Notes

Measure your actual product for rough-in details.

Install this product according to the installation instructions.

The hot water supply should be 70% of the capacity of the bath or greater. Installations will vary.

Remote blower installation kit is available for relocating the blower. Provide access for servicing the blower.

Do not relocate or alter the PVC tee or coiled flexible tubing connected to the blower. Follow the blower relocation instructions exactly.

ADA compliant when installed to the specific requirements of these regulations.